

TrueFlame 60" Vent Hood

SKU: SSVH-60

NOTES

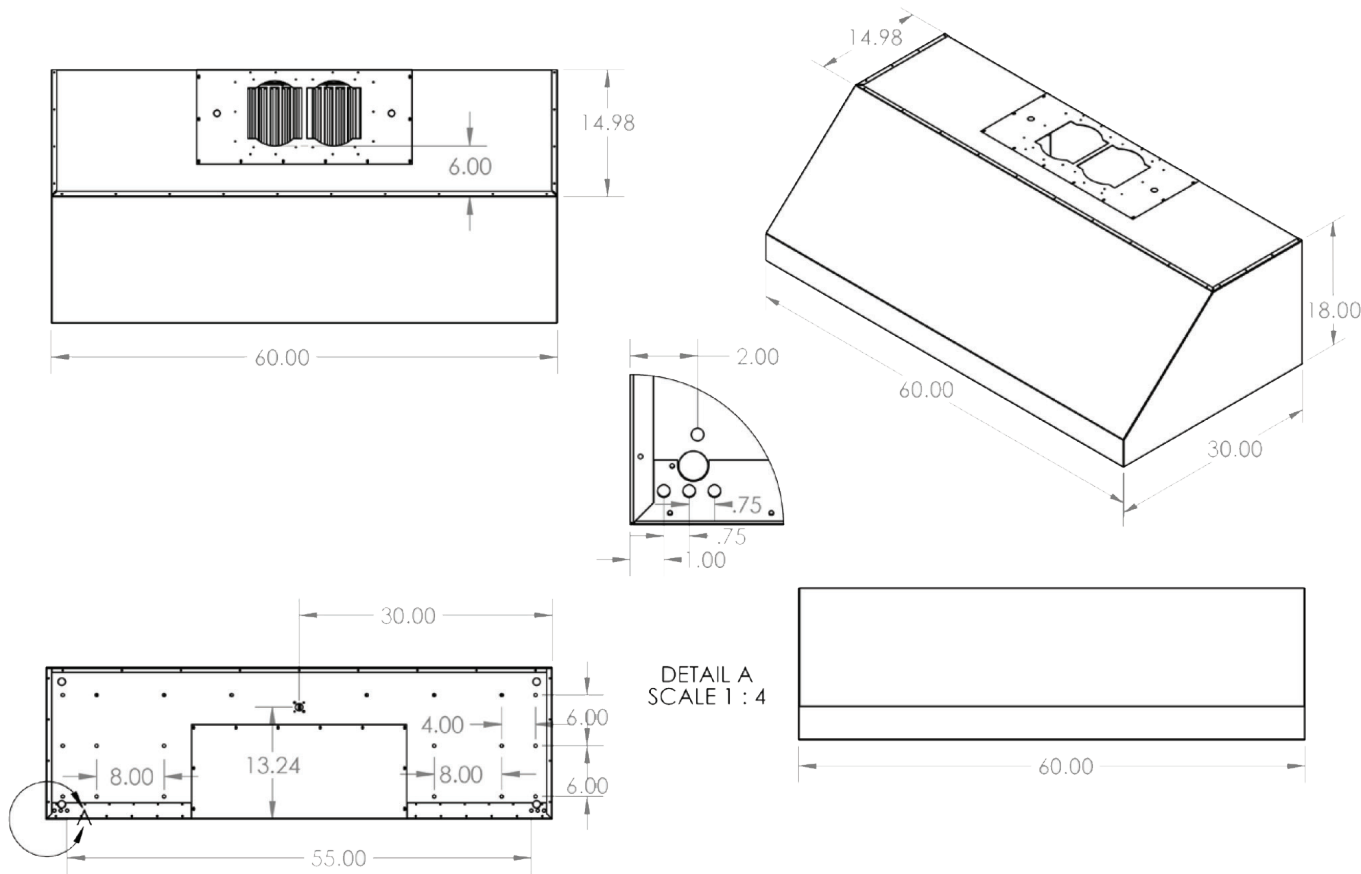

DISCLAIMER

We recommend adding a 1/4" (.25) to the inner dimension to ensure the unit fits properly in the build out.